

GCL-1 Fedélzeti izzító

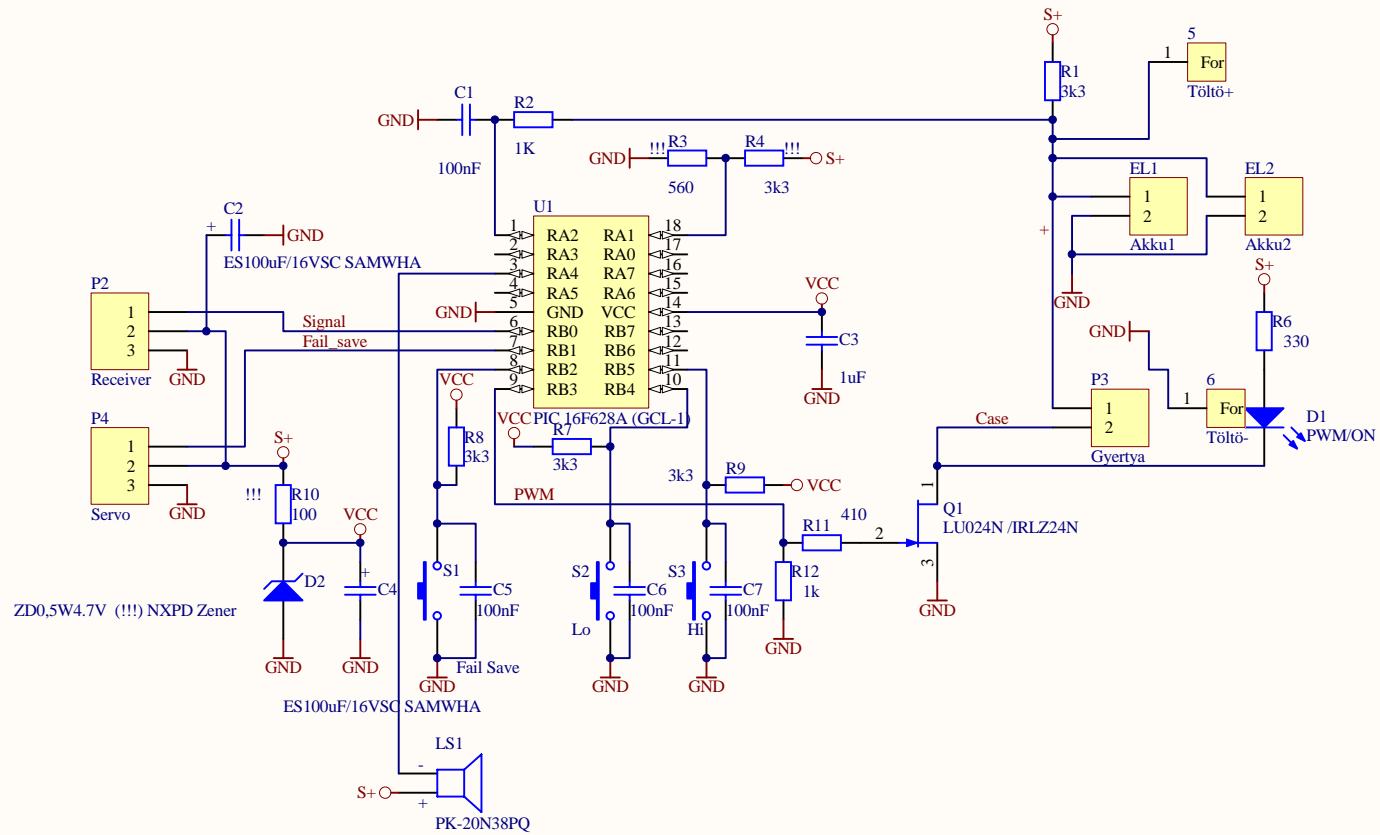

Title			Izzító / Fail Save		
Size	Number	Revision			
A4	1	5			
Date:	2011.08.21.	Sheet of			
File:	C:\Documents and Settings\...\Izzito_kit.Sch	Drawn By:	Magi István		

rc-miskolc.emiter.hu

5

R2 C1

6

On Board Glow Logic

M & V
Elektronika Kft.



Q1

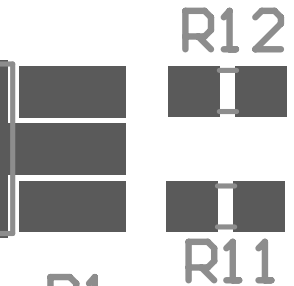

R1

R12

R11

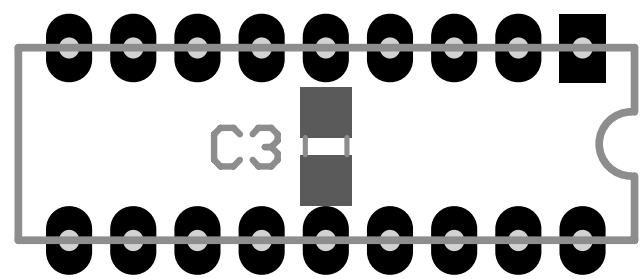

U1

C3

R3

R4

Made in Hungary



R6



R9



R7



R8

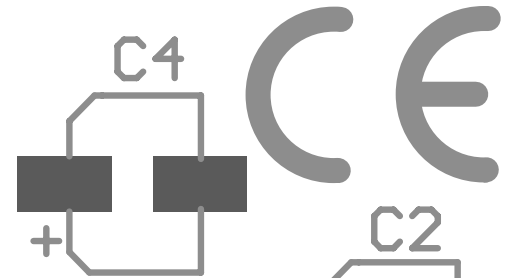

C4

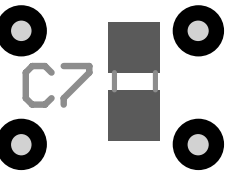
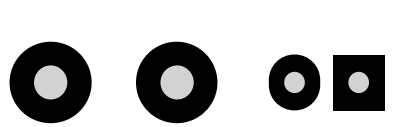

C7

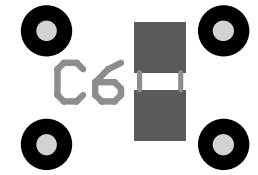

C6

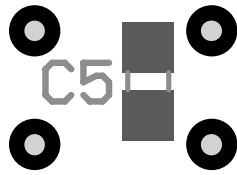
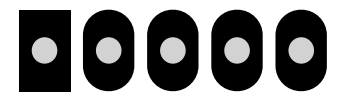

C5

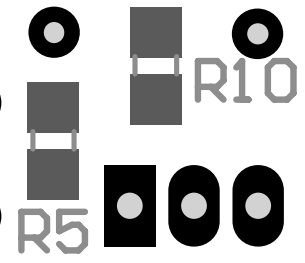

R5

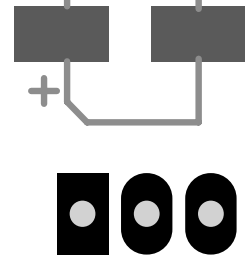

C2

R10

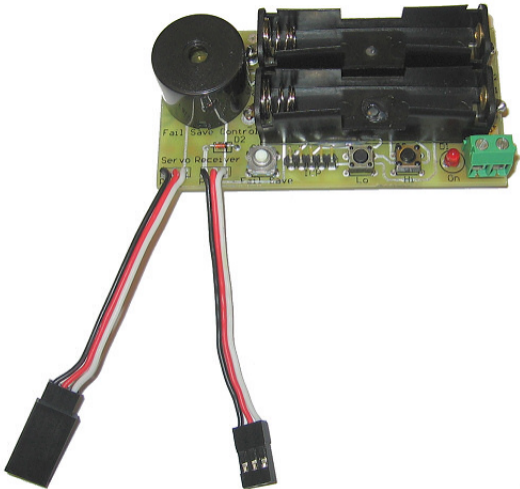

rc-miskolc.emi ter.hu

On Board Glow Logic

M & V
Elektronika Kft.

Made in Hungary

CE

